

Product Features

Technical parameter

Concise appearance ,smart design ,easy installtion .
Multiple combination ,widly used in commercial office
and home area.

										Desk thickness application (mm)	
LCD Size	Wt.Capacity (kg)	Post Height (mm)	Tilt	Swivel	Pivot	VESA	Packing size (mm)	NW (kg)	GW (kg)	Thru desk	desk clamp
≤30"	≤8	400	+85°~-60°	360°	±90°	75*75 100*100	Inner : 570*340*120 outer : 585*355*375 inner/outer : 3/1	Inner : 3.9 outer : 11.7	Inner : 4.8 outer : 16.2	10~50	15~50

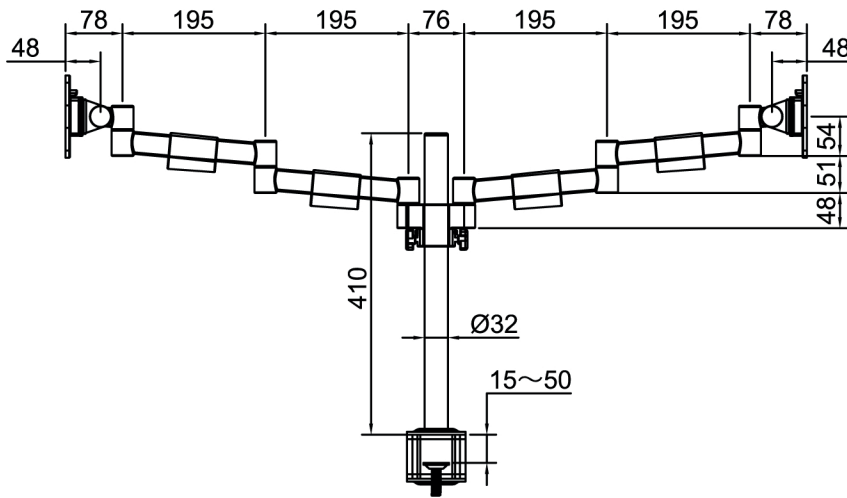

Product Dimensions

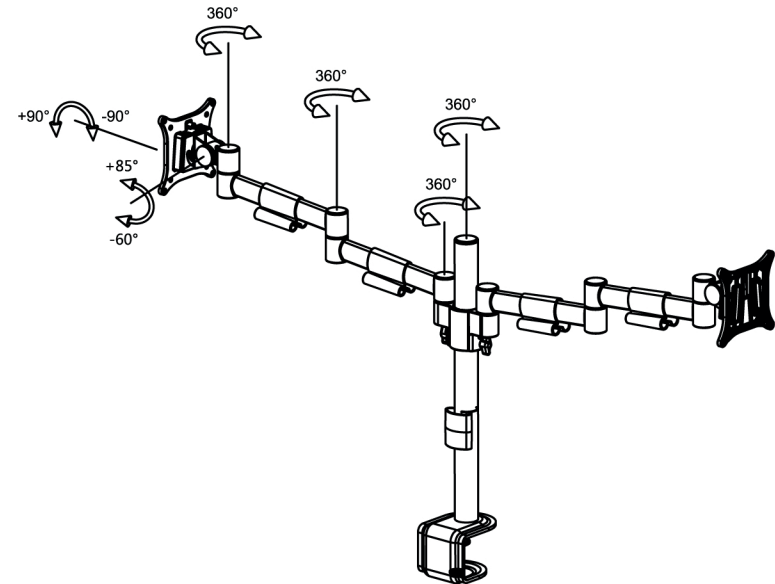

Multifunctional adjustment figure