



















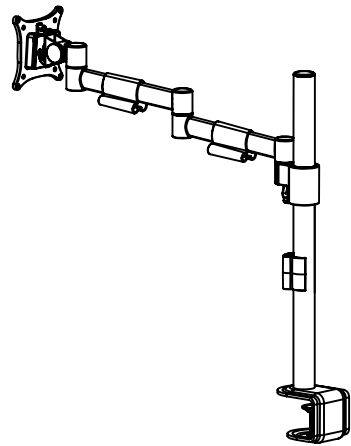

Installation Manual









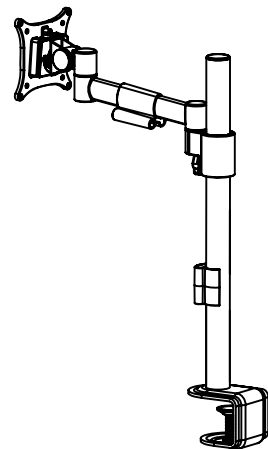

Parts list

No.	ITEM	SPECS	QUANTITY
A			4
B			4
C		M6	1
D		M4	1
F		M2.5	1
G			1
H			1
I			1
J		M8*90	1
K			1



No.	ITEM	SPECS	QUANTITY
A			4
B			4
C		M6	1
D		M4	1
F		M2.5	1
G			1
H			1
I			1
J		M8*90	1
K			1





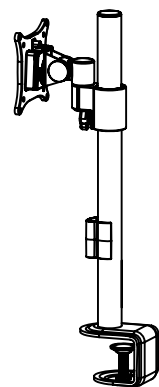









No.	ITEM	SPECS	QUANTITY
A			4
B			4
C		M6	1
D		M4	1
F		M2.5	1
G			1
H			1
I			1
J		M8*90	1
K			1









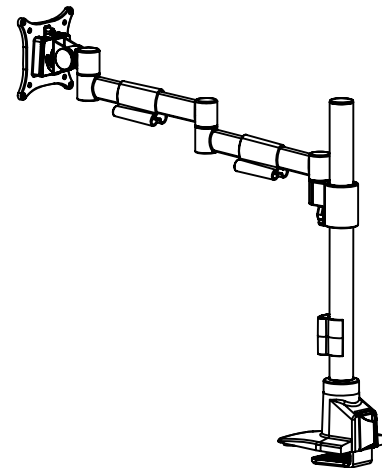





Installation Manual









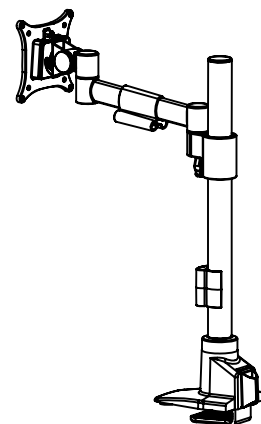



Parts list

No.	ITEM	SPECS	QUANTITY
A			4
B			4
C		M6	1
D		M4	1
E		M3	1
F		M2.5	1
G			1
H			1
I			1
L		set screws M6*6	1
M			1
N		M8*160	1



No.	ITEM	SPECS	QUANTITY
A			4
B			4
C		M6	1
D		M4	1
E		M3	1
F		M2.5	1
G			1
H			1
I			1
L		set screws M6*6	1
M			1
N		M8*160	1





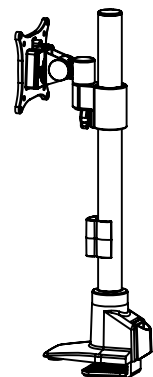









No.	ITEM	SPECS	QUANTITY
A			4
B			4
C		M6	1
D		M4	1
E		M3	1
F		M2.5	1
G			1
H			1
I			1
L		set screws M6*6	1
M			1
N		M8*160	1









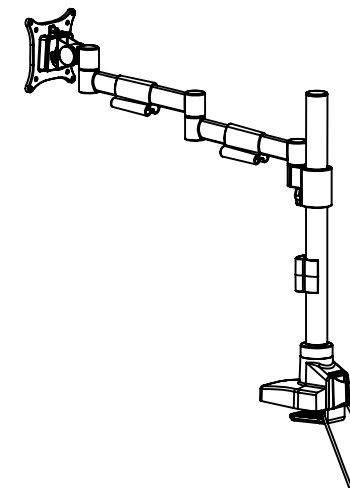





Installation Manual









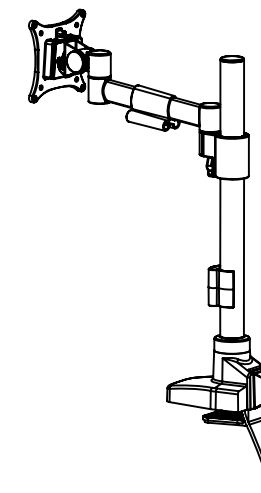



Parts list

No.	ITEM	SPECS	QUANTITY
A			4
B			4
C		M6	1
D		M4	1
E		M3	1
F		M2.5	1
G			1
H			1
I			1
L		set screws M6*6	1
M			1
N		M8*160	1



No.	ITEM	SPECS	QUANTITY
A			4
B			4
C		M6	1
D		M4	1
E		M3	1
F		M2.5	1
G			1
H			1
I			1
L		set screws M6*6	1
M			1
N		M8*160	1



No.	ITEM	SPECS	QUANTITY
A			4
B			4
C		M6	1
D		M4	1
E		M3	1
F		M2.5	1
G			1
H			1
I			1
L		set screws M6*6	1
M			1
N		M8*160	1

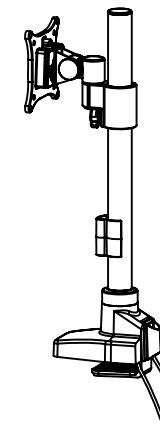

Installation Manual

Clamp Installation

I	Desk Clamp		
	Thru-Desk		
II	Desk Clamp		
	Thru-Desk		
III	Desk Clamp		
	Thru-Desk		

Installation Manual

Arm Installation

Installation Manual

Arm Adjustment
